

120mm sq.

San Ace 120L



General Specifications

- Material Frame: Aluminum,
Impeller: Plastics (Flammability: UL94V-1)
- Expected Life Refer to specifications (L10:Survival rate:90% at 60°C ,
rated voltage, and continuously run in a free air state)
- Lead Wire ⊕red ⊖black (Sensor) yellow (Control) brown
- Storage Temperature -30°C to +70°C (Non-condensing)

120×120×38mm [Mass : 420g] **9LG type** **High Airflow**



Specifications

The following nos. **have PWM controls and pulse sensors.**

Model No.	Rated Voltage [V]	Operating Voltage Range [V]	PWM duty cycle ^{Model#} [%]	Rated Current [A]	Rated Input [W]	Rated Speed [min ⁻¹]	Max. Airflow [m ³ /min] [CFM]	Max. Static Pressure [Pa] [inchH ₂ O]	SPL [dB(A)]	Operating Temperature [°C]	Expected Life [h]
9LG1212P1G001	12	8.0 to 13.8	100	3.2	38.4	6,550	7.00 247.1	370 1.48	62	-20 to +70	180,000/60°C
			20	0.24	2.88	2,000	2.13 75.2	34.4 0.13	36		
9LG1212P1S001			100	2.2	26.4	5,600	6.00 211.8	270 1.08	58		
			20	0.24	2.88	2,000	2.13 75.2	34.4 0.13	36		
9LG1212P1H001			100	1.4	16.8	4,700	5.00 176.5	190 0.76	54		
			20	0.24	2.88	2,000	2.13 75.2	34.4 0.13	36		
9LG1224P1G001	24	15 to 30	100	1.6	38.4	6,550	7.00 247.1	370 1.48	62		
			20	0.12	2.88	2,000	2.13 75.2	34.4 0.13	36		
9LG1224P1S001			100	1.1	26.4	5,600	6.00 211.8	270 1.08	58		
			20	0.12	2.88	2,000	2.13 75.2	34.4 0.13	36		
9LG1224P1H001			100	0.7	16.8	4,700	5.00 176.5	190 0.76	54		
			20	0.12	2.88	2,000	2.13 75.2	34.4 0.13	36		
9LG1248P1G001	48	36 to 60	100	0.8	38.4	6,550	7.00 247.1	370 1.48	62		
			20	0.08	3.84	2,000	2.13 75.2	34.4 0.13	36		
9LG1248P1S001			100	0.55	26.4	5,600	6.00 211.8	270 1.08	58		
			20	0.08	3.84	2,000	2.13 75.2	34.4 0.13	36		
9LG1248P1H001			100	0.35	16.8	4,700	5.00 176.5	190 0.76	54		
			20	0.08	3.84	2,000	2.13 75.2	34.4 0.13	36		

Note : Fan does not rotate when PWM duty cycle is 0%.

*PWM Frequency : 25kHz

Other sensor specifications are available as options. Please refer to the index (p. 509).

Dimensions (unit: mm)

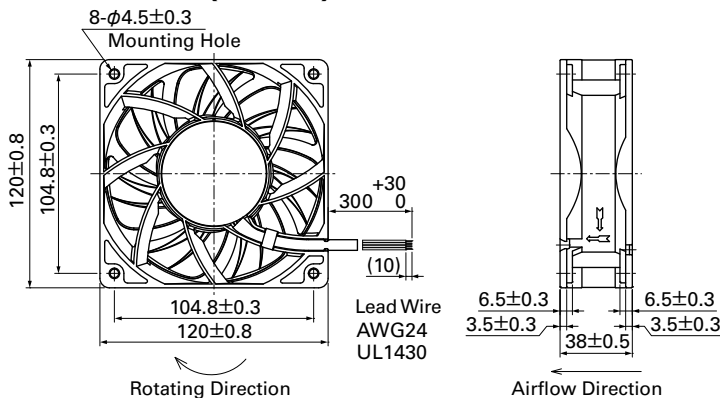

Options (unit: mm)

Finger Guards
 Model : 109-019C Surface treatment : Nickel-chrome plating (silver)
 : 109-019H : Cation electropainting (black)

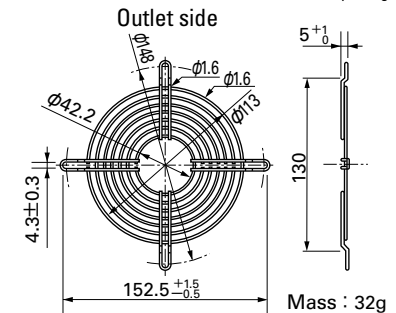

Model : 109-019E Surface treatment : Nickel-chrome plating (silver)
 : 109-019K : Cation electropainting (black)

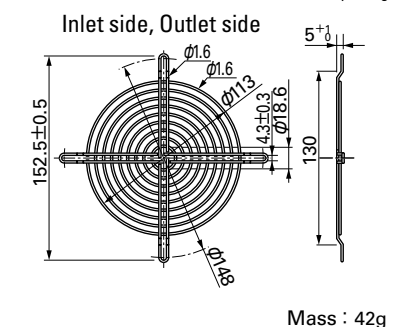

Reference Dimensions of Mounting Holes and Vent Opening (unit: mm)

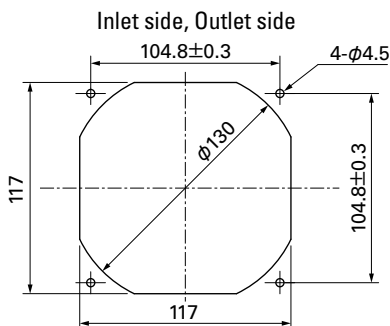

Options (unit: mm)

Resin Finger Guards

Model : 109-1000G

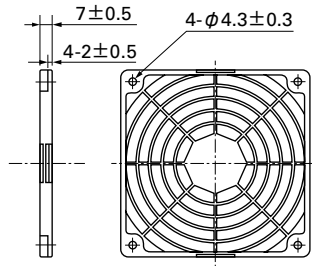
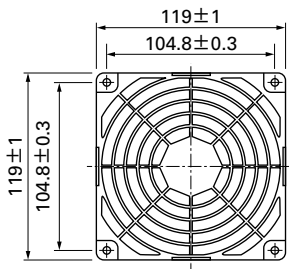

Mass : 23g

Resin Filter Kits

Model : 109-1000F13 (13PPI), 109-1000F20 (20PPI)
: 109-1000F30 (30PPI), 109-1000F40 (40PPI)

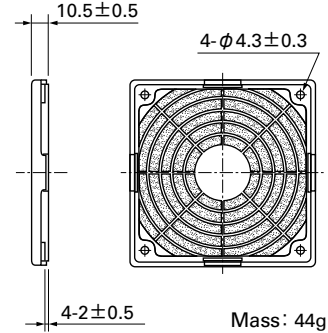
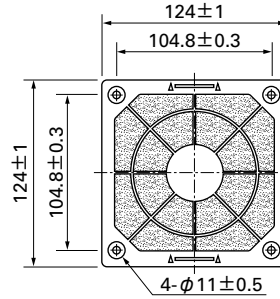

Mass : 44g

Airflow - Static Pressure Characteristics

PWM Duty Cycle

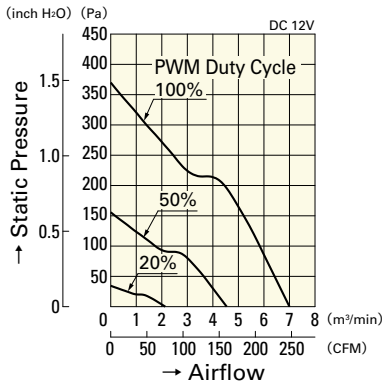

9LG1212P1G001

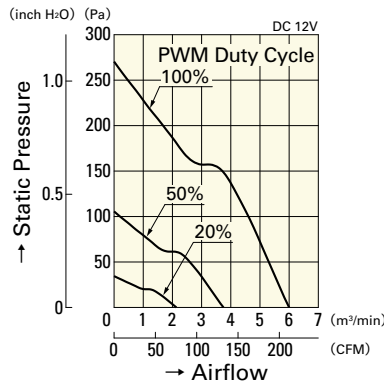

9LG1212P1S001

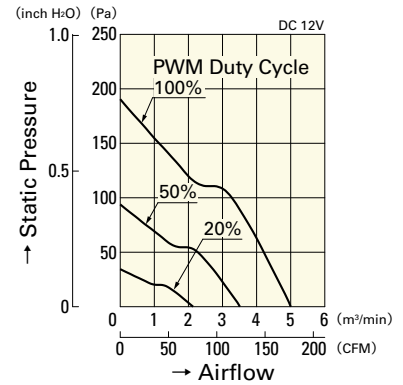

9LG1212P1H001

Operating Voltage Range

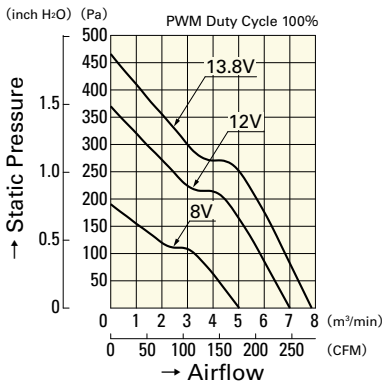

9LG1212P1G001

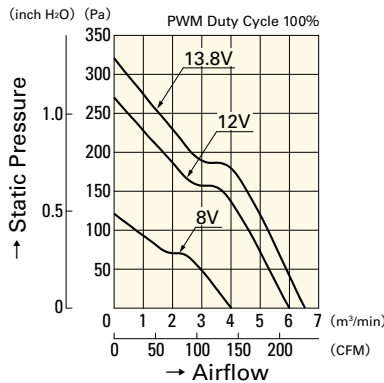

9LG1212P1S001

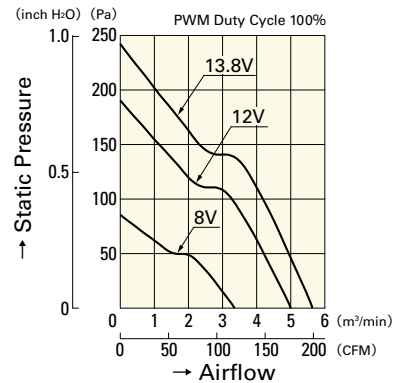

9LG1212P1H001

PWM Duty - Speed Characteristics Example

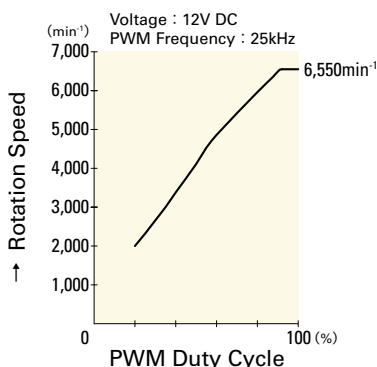

9LG1212P1G001

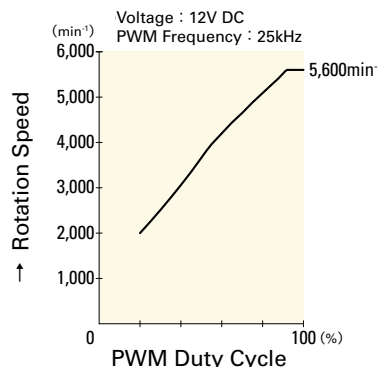

9LG1212P1S001

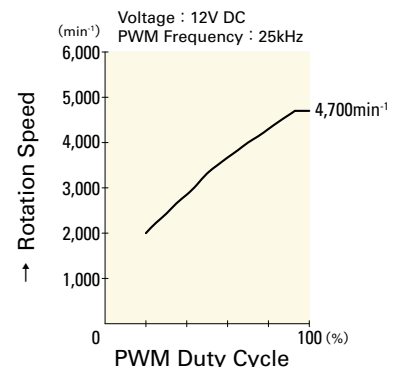

9LG1212P1H001

DC

Long Life Fan 120mm

120mm sq.

San Ace 120L

120×120×38mm [Mass : 420g]

Airflow - Static Pressure Characteristics

PWM Duty Cycle

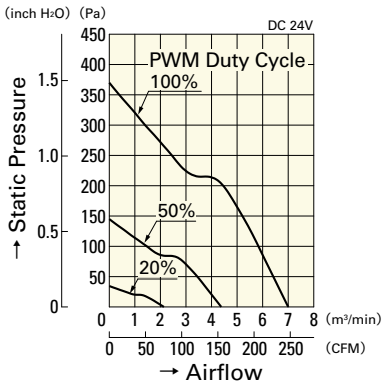

9LG1224P1G001

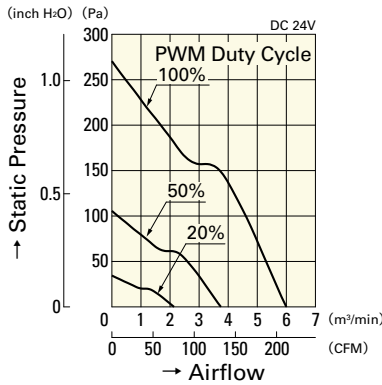

9LG1224P1S001

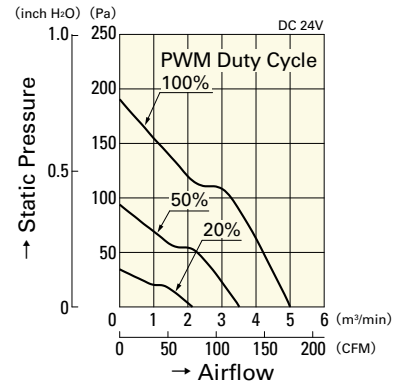

9LG1224P1H001

Operating Voltage Range

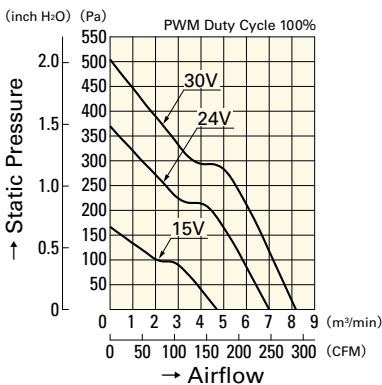

9LG1224P1G001

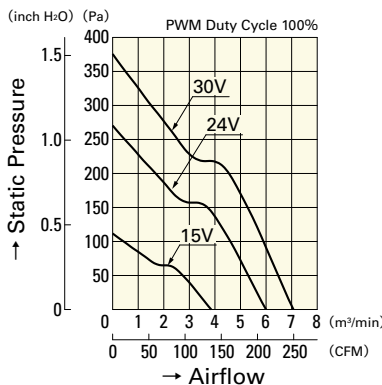

9LG1224P1S001

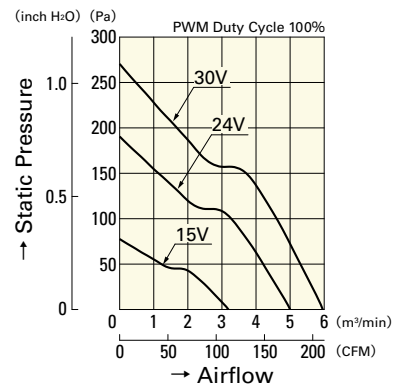

9LG1224P1H001

PWM Duty - Speed Characteristics Example

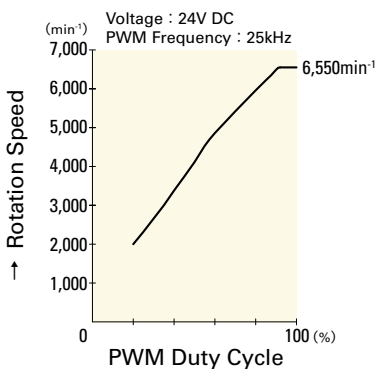

9LG1224P1G001

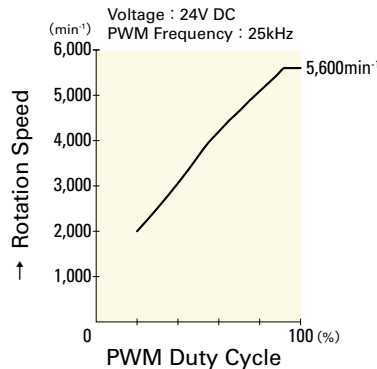

9LG1224P1S001

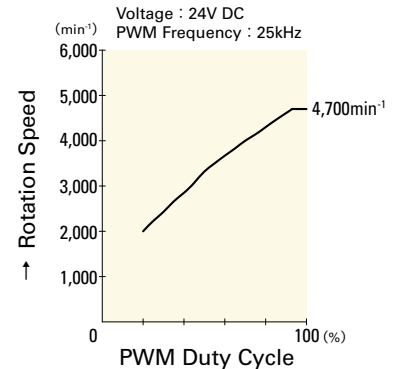

9LG1224P1H001

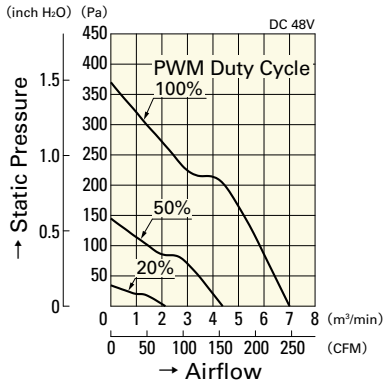

9LG1248P1G001

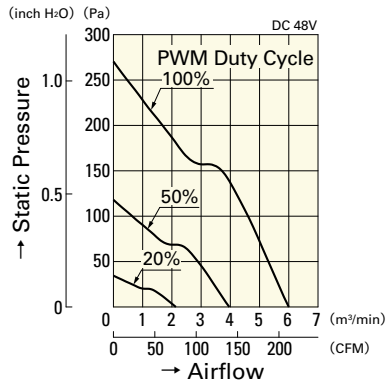

9LG1248P1S001

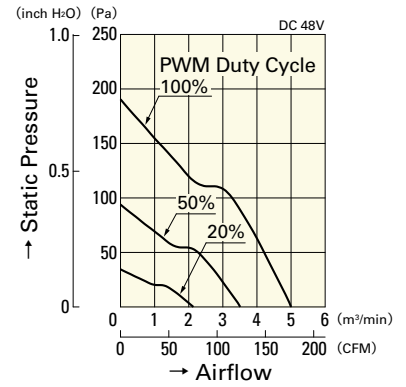

9LG1248P1H001

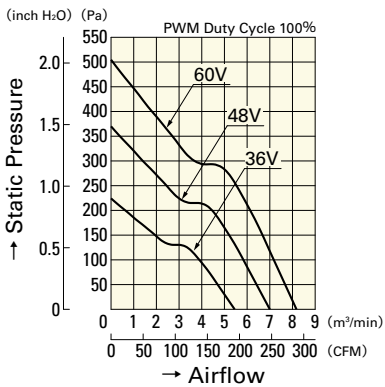

9LG1248P1G001

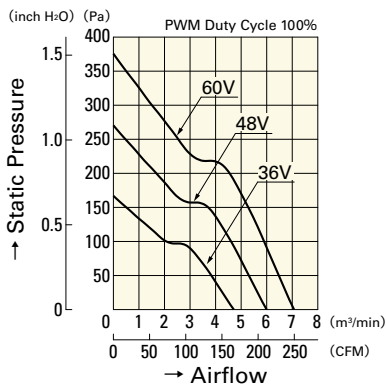

9LG1248P1S001

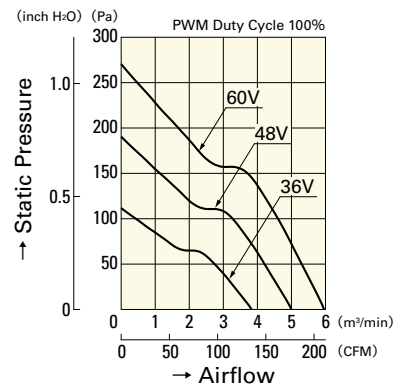

9LG1248P1H001

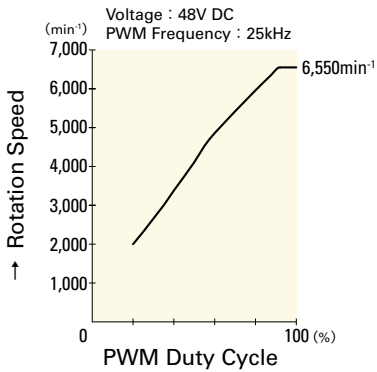

9LG1248P1G001

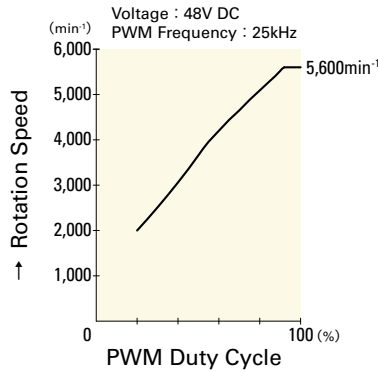

9LG1248P1S001

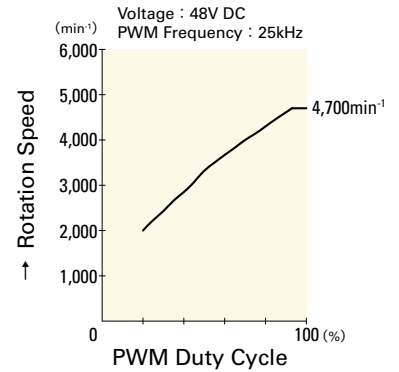

9LG1248P1H001